

Micro-D Filter Connectors Vertical Printed Circuit Board



Printed Circuit Board Micro-D Filter Connectors. These vertical mount PCB connectors are ideal for flexible circuit or motherboard applications.

Key Features include gold plated TwistPin contacts, machined aluminum shells, and either Pi or C filter elements. These environmentally sealed connectors are designed to meet the requirements of MIL-DTL-83513.

Integral Board Standoffs and Pre-Tinned Tails—These connectors are solder dipped (63/37 SnPb) and feature a full complement of mounting hardware options.

HOW TO ORDER MICRO-D FILTER VERTICAL MOUNT PCB CONNECTORS

Series	Shell Finish	Number of Contacts	Contact Type	Filter Type	Filter Class	PC Tail Length	Hardware Option	
240-031	1 – Cadmium	9	P Pin	C C Filter	A	1 – .110 Inches (2.79) 2 – .250 Inches (6.35) Length in Inches ± .015 (0.38)	NN – No Jackpost, No Threaded Insert PN – Extended Jackpost for .062" (1.6) PCB, No Threaded Insert RN – Extended Jackpost for .196" (5.0) PCB, No Threaded Insert NU – Threaded Insert Only, No Jackposts PU – Short Jackpost and Threaded Insert Rear Panel Jackposts With Threaded Inserts R6U – 0.125" (3.2) Panel R5U – 0.094" (2.4) Panel R4U – 0.062" (1.6) Panel R3U – 0.047" (1.2) Panel R2U – 0.031" (0.8) Panel JackscREW Options M – Hex Head Jackscrews S – Slot Head Jackscrews	
	2 – Nickel	15						
	4 – Black Anodize	21	S Socket	P Pi Filter	B			
		25						
		5 – Gold	31					C
		6 – Chem Film	37					D
					E			
					F			
					G			
Sample Part Number								
240-031	2	– 25	P	C	D	1	PN	



MICRO-D FILTER VERTICAL PCB DIMENSIONS

Layout	A Max.		B		C Max.		D Max.		E Max.		F	
	In.	mm.	In. ± .003	mm. ± 0.08	In.	mm.	In.	mm.	In.	mm.	In. ± .004	mm. ± 0.10
9P	.785	19.94	.565	14.35	.333	8.46	.184	4.67	.310	7.87	.183	4.65
9S	.785	19.94	.565	14.35	.400	10.16	.250	6.35	.310	7.87	.195	4.95
15P	.935	23.75	.715	18.16	.483	12.27	.184	4.67	.310	7.87	.183	4.65
15S	.935	23.75	.715	18.16	.551	14.00	.250	6.35	.310	7.87	.195	4.95
21P	1.085	27.56	.865	21.97	.633	16.08	.184	4.67	.310	7.87	.183	4.65
21S	1.085	27.56	.865	21.97	.701	17.81	.250	6.35	.310	7.87	.195	4.95
25P	1.185	30.01	.965	24.51	.733	18.62	.184	4.67	.310	7.87	.183	4.65
25S	1.185	30.01	.965	24.51	.801	20.35	.250	6.35	.310	7.87	.195	4.95
31P	1.335	33.91	1.115	28.32	.883	22.43	.184	4.67	.310	7.87	.183	4.65
31S	1.335	33.91	1.115	28.32	.951	24.16	.250	6.35	.310	7.87	.195	4.95
37P	1.485	37.72	1.265	32.13	1.033	26.24	.184	4.67	.310	7.87	.183	4.65
37S	1.485	37.72	1.265	32.13	1.101	27.96	.250	6.35	.310	7.87	.195	4.95

MICRO-D FILTER VERTICAL PCB HARDWARE OPTIONS

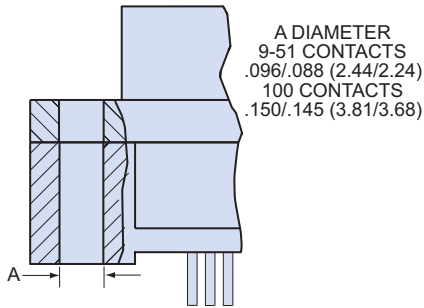

NN Style

Connector Supplied Without Hardware
Thru-Hole, No Hardware



NU Style

Connector Supplied With Threaded Inserts



PU Style

Jackpost with Threaded Insert



RU Style

Rear Panel Jackpost with Threaded Insert



Extended Jackpost
PN Style for .062" PCB
RN Style for .196" PCB

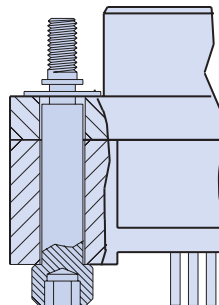

M Style

Hex Head Jackscrew with E-Ring



S Style

Slot Head Jackscrew with E-Ring

F

MICRO-D FILTER VERTICAL PCB LAYOUTS— PIN CONNECTOR SHOWN

PC Tail Diameter $.018 \pm .002$ (0.46 ± 0.05)

Contact numbers shown are for pin connectors. Reverse for socket.

Patterns shown are for connector mounting side of PC board.



9 Contacts

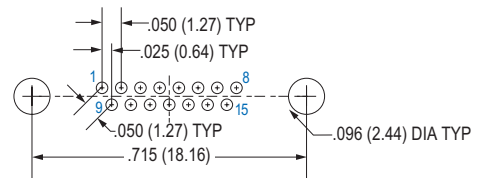

15 Contacts

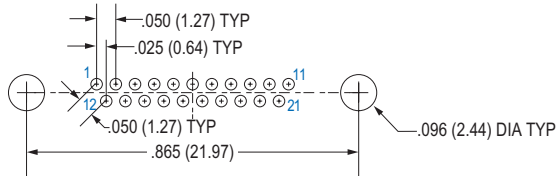

21 Contacts

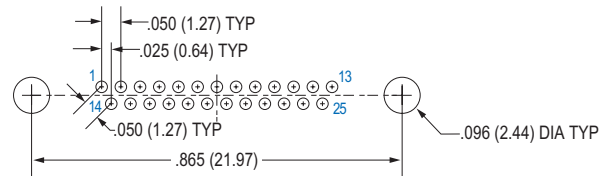

25 Contacts

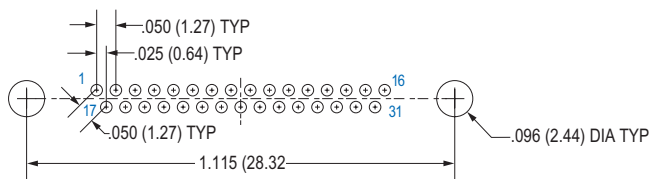

31 Contacts

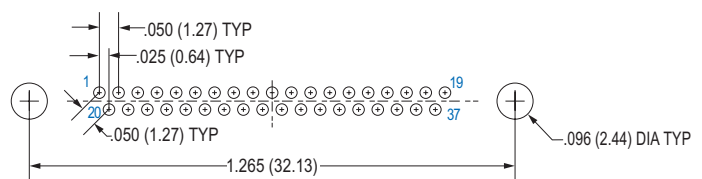

37 Contacts